

Series 207 Product Overview

Features:

- Largest selection of arm and mounting options
- Low profile T-Handle version available
- Available in stainless steel

Applications:

- Checking fixtures
- Assembly & test
- Light machining
- Woodworking

Also Available:

See page 8.1 for accessories

807-U Pneumatic toggle clamp
(See page 10.7)

807-S Pneumatic toggle clamp
(See page 10.7)

Accepts M8 or 5/16 spindle accessories

207-U[†]
Flanged Base
U-Bar

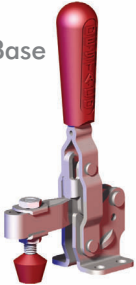

207-UL
Flanged Base
Long U-Bar

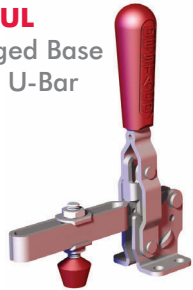

207-USS
Stainless
Flanged Base
U-Bar

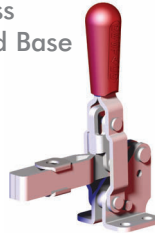

207-S
Flanged Base
Solid Bar

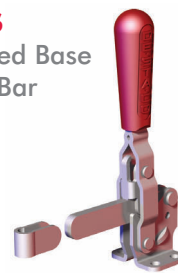

207-L
Flanged Base
Long Solid Bar

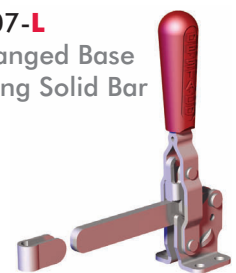

207-TU
Flanged Base
T-Handle
U-Bar

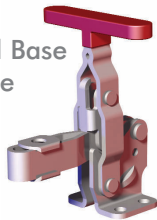

207-TUL
Flanged Base
T-Handle
Long U-Bar



207-UR[†]
Flanged Base
U-Bar
with
DE-STA-CO[®]
Toggle Lock
Plus



207-LR
Flanged Base
Long Solid Bar
with
DE-STA-CO[®]
Toggle Lock
Plus



207-UB[†]
Straight Base
U-Bar

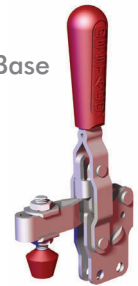

207-ULB[†]
Straight Base
Long U-Bar

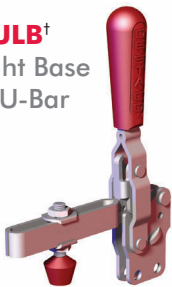

207-SB
Straight Base
Solid Bar



207-LB
Straight Base
Long Solid
Bar



207-LBR^①
Straight Base
Long Solid
Bar with
DE-STA-CO[®]
Toggle Lock
Plus



207-UF^①
U-Bar
Dual Mount



207-SF^①
Solid Bar
Dual Mount

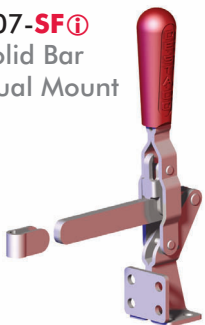

207-U-L^①
Flange Base
Open Bar



207-UB-L^①
Straight Base
Open Bar



Note:

Clamps shown with included accessories

[†]To order without spindle, add (-LS) to the end of model

(Ex: 207-UB-LS)

^① This item is available upon request

Series 207 Technical Information

Model	Max. Holding Capacity	Clamp Bar Opening (+10°)	Handle Opening (+10°)	Weight	Accessories (Supplied)								
					Bolt Retainer	Spindle Assembly	Flanged Washers						
207-U	1670 N [375 lbf]	99°	57°	0,30kg [0.67lb]	---	225208-M	507107						
207-UR				0,45kg [1.00lb]									
207-UL				0,30kg [.67lb]									
207-USS	2000 N [450 lbf]			---	---	0,32kg [0.70lb]	---	507907					
207-S	2220 N [500 lbf]			99°	57°	0,31kg [0.69lb]	207105	---	---				
207-L						0,34kg [0.74lb]							
207-LR						0,45kg [1.00lb]							
207-UB	1670 N [375 lbf]					99°	57°	0,33kg [0.72lb]	---	225208-M	507107		
207-ULB								0,31kg [0.69lb]					
207-SB								0,34kg [0.75lb]					
207-LB	2220 N [500 lbf]							207105	---	---	207105	---	---
207-LBR ⓘ	0,45kg [1.00lb]												
207-TU	1670 N [375 lbf]	99°	57°										
207-TUL								0,33kg [0.72lb]					
207-UF ⓘ	1670 N [375 lbf]							96°	56°	0,43kg [0.94lb]	---	225208-M	507107
207-SF ⓘ	2220 N [500 lbf]							90°	57°	0,38kg [0.84lb]	207105	---	---
207-U-L ⓘ	1670 N [375 lbf]			99°	57°			0,38kg [0.84lb]	---	---	---		
207-UB-L ⓘ													

ⓘ This item is available upon request

Series 207 Holding Capacities

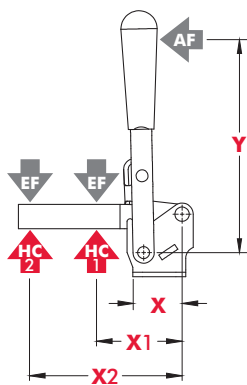

Model	X	X1	X2	Y	±HC1	±HC2	±EF(X1):AF	±EF(X2):AF
U/UB/UR		[2.00] 50,8	[3.75] 95,3		[375 lbf] 1670N	[225 lbf] 1000N	12:1	6:1
UL/ULB		[3.88] 98,5	[5.00] 127			[150 lbf] 670N	7:1	4:1
USS		[2.00] 50,8	[3.75] 95,3	[4.90] 124,5	[450 lbf] 2000N	[1070 lbf] 240N		5:1
S/SB		[2.88] 73,0	[5.00] 127		[500 lbf] 2220N	[350 lbf] 1560N	10:1	7:1
L/LR LB/LBR	[1.28] 32,6	[2.88] 73,0	[5.00] 127					5:1
TU		[2.00] 50,8	[3.75] 95,3	[3.66] 9	[375 lbf] 1670N	[225 lbf] 1000N	6:1	4:1
TUL		[3.88] 98,5	[5.00] 127			[150 lbf] 670N	4:1	3:1
U-L		[2.00] 50,8	[3.75] 95,3	[4.90] 124,5	[375 lbf] 1670N	[2225 lbf] 1000N	12:1	6:1
UB-L								

Dimensions shown "mm [inch]" ± HC = Holding Capacity, EF = Exerting Force, AF = Applied Force

Series 207 Standard Clamp Dimensions

-U/-UL/-S/-L/-TU/-TUL/-UR/-LR/-UB/-ULB/-SB/-LB/-LBR

207-U[†]
Flanged Base
U-Bar

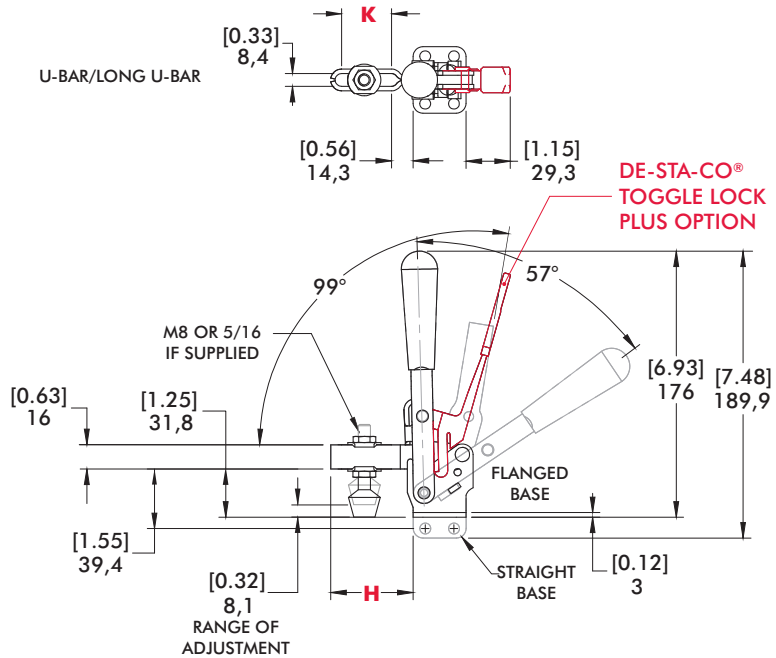
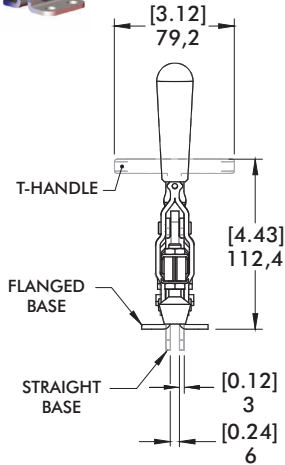

207-SB
Straight Base
Solid Bar

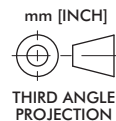
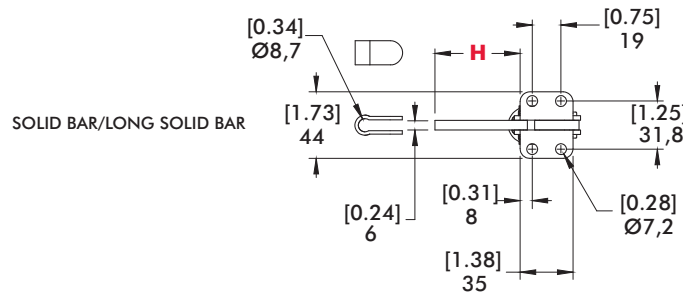
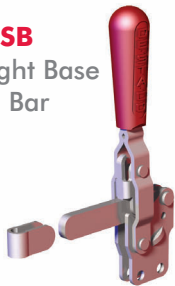

Bar Style	Clamp Models	H	K
	207-U/207-UR/207-TU/207-UB	[2.14] 54,4	[1.30] 33
	207-UL/207-ULB/207-TUL	[3.84] 97,6	[2.94] 74,6
	207-S/207-SB/207-TS	[2.21] 56,2	---
	207-L/207-LR/207-LB/207-LBR ⓘ	[3.48] 88,4	---

ⓘ This item is available upon request

Series 207 Standard Clamp Dimensions - Dual Mount

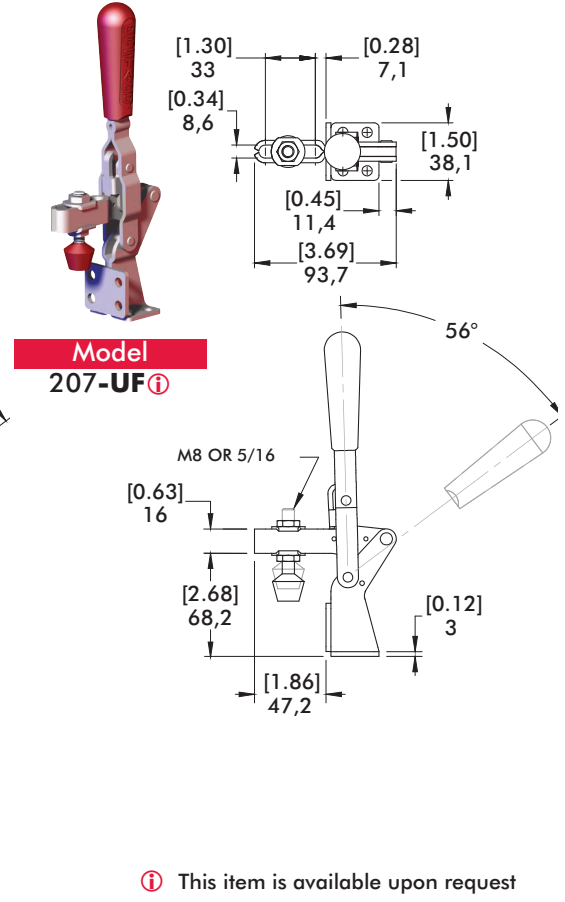
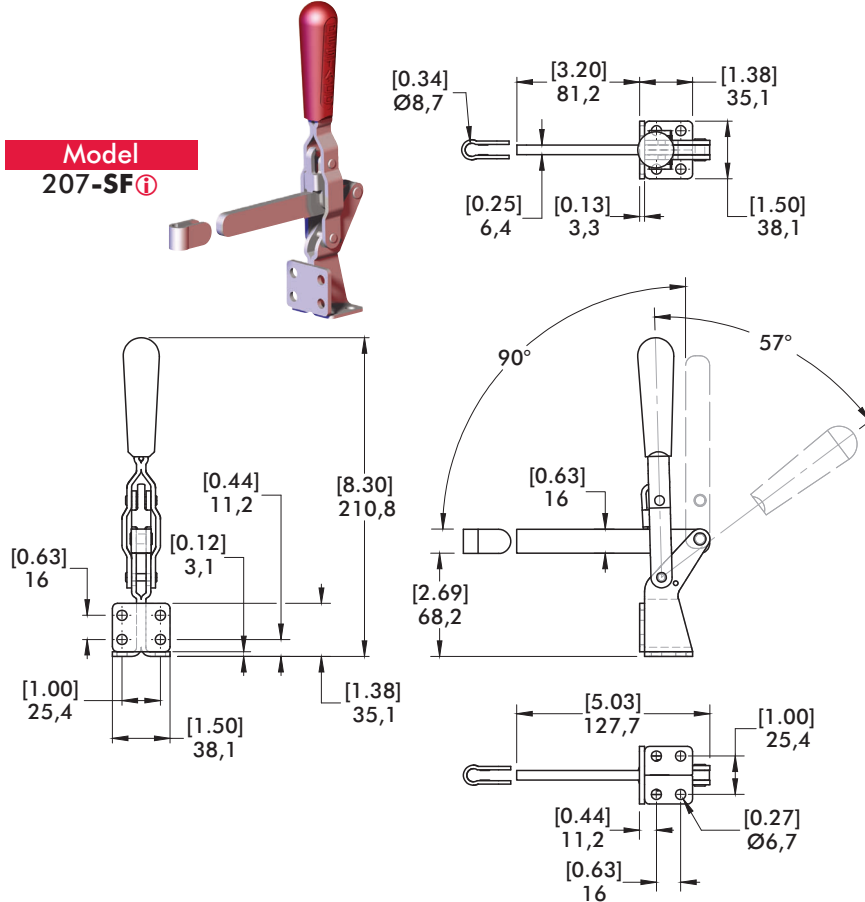

ⓘ This item is available upon request

Series 207 Open Bar

207-USS Stainless Steel

See page 8.7 for Complete offering of Open bar accessories

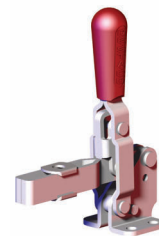
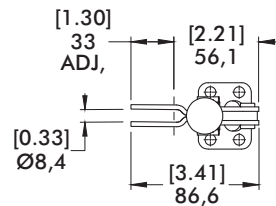

Model 207-USS

