

Series 247, 267 Product Overview

Features:

- Hardened steel bushings
- Large bar guides for greater lateral stability on Model 247
- Series 247 accommodates M12 or 1/2 spindle accessory
- Series 267 accommodates M16 or 5/8 spindle accessory

Applications:

- Assembly & test
- Light machining
- Welding

Also Available:

See page 8.1 for accessories
 847-U Pneumatic Toggle Clamp
 (See page 10.15)
 847-S Pneumatic Toggle Clamp
 (See page 10.15)

247-U
Flanged Base
U-Bar

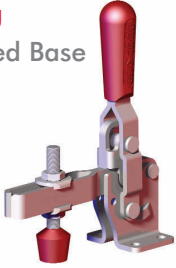

247-S
Flanged Base
Solid Bar

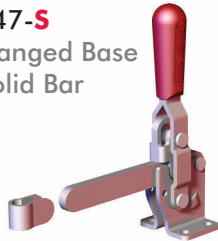

247-UB ⓘ
Straight Base
U-Bar

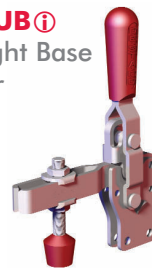

267-U
Flanged Base
U-Bar

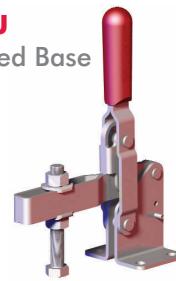

267-S ⓘ
Flanged Base
Solid Bar



Note:
 Clamps shown with included accessories. To order without spindle, add (-LS) to the end of model (Ex: 247-U-LS)

Series 247, 267 Technical Information

Model	Max. Holding Capacity	Clamp Bar Opening (+10°)	Handle Opening (+10°)	Weight	Accessories (Supplied)		
					Bolt Retainer	Spindle Assembly	Flanged Washers
247-U				1,07kg [2.36lbs]	---	247208-M	247109
247-S	4400 N [1000 lbf]	120°	67°	1,08kg [2.36lbs]	210114	---	---
247-UB ⓘ				1,07kg [2.36lbs]	---	247208-M	247109
267-U				2,18kg [4.80lbs]	---	247203-M	267102
267-S ⓘ	5340 N [1200 lbf]	140°	72°	1,98kg [4.36lbs]	110122	---	---

ⓘ This item is available upon request

Series 247 Holding Capacities

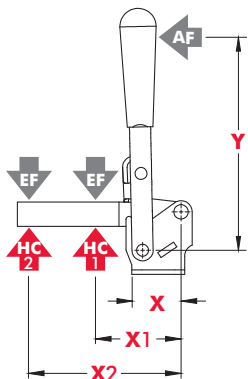

Model	X	X1	X2	Y	±HC1	±HC2	±EF(X1):AF	±EF(X2):AF
247-U/ 247-UB ⓘ	[1.69]	[3.00] 76,2	[6.13] 155,7	[6.71]	[1000lbf.]	[480lbf.] 2140N	12:1	6:1
247-S	43	[4.56] 115,8	[7.00] 177,8	170,5	4450N	[650lbf.] 2900N	10:1	5:1
267-U	[2.50]	[4.00] 101,6	[8.00] 203,2	[9.25]	[1200lbf.]	[600lbf.] 2670N	18:1	8:1
267-S ⓘ	63,5	[6.00] 152,4	[8.75] 222,3	235	5340N	[820lbf.] 3650N	12:1	

Dimensions shown "mm [inch]" ± HC = Holding Capacity, EF = Exerting Force, AF = Applied Force
 Refer to page 20.5 for additional information. ⓘ This item is available upon request

Series 247 Standard Clamp Dimensions
-U/-S/-UB

247-U
Flanged Base
U-Bar

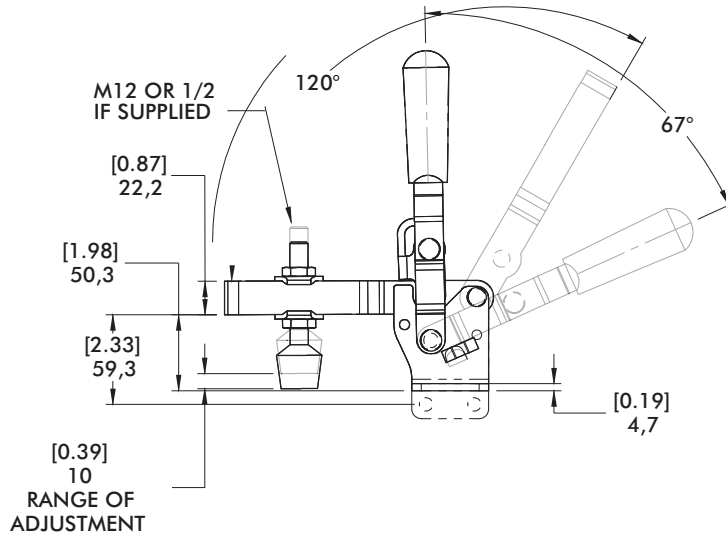
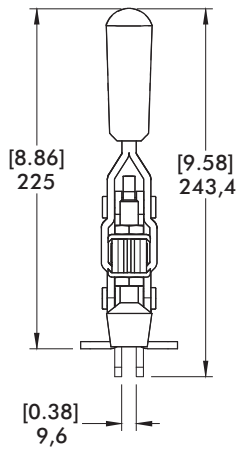
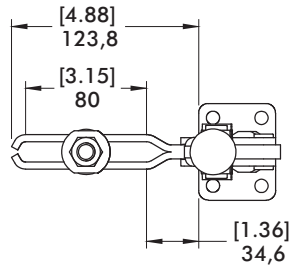
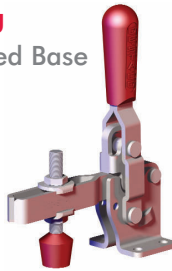

247-S
Flanged Base
Solid Bar

